

TheCornerGuardStore

Un-Anodized Aluminum Corner Guard

48" x 3" x 3" x 90°

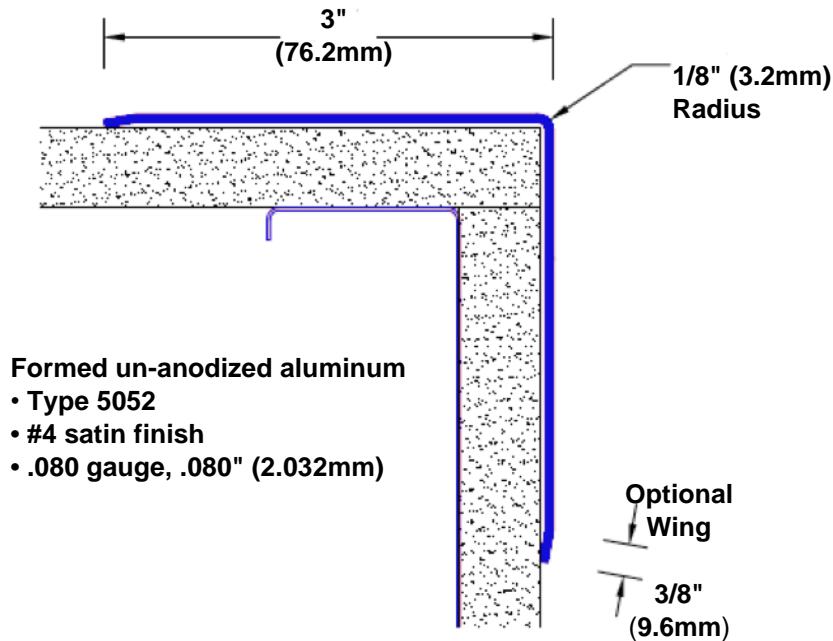

Formed un-anodized aluminum

- Type 5052
- #4 satin finish
- .080 gauge, .080" (2.032mm)

Features:

- Custom lengths, angles and wing sizes
- Available with 3/4" (19) radius
- Type 5052 un-anodized aluminum
- Stock lengths: 4' (1219mm) & 8' (2438mm)

Mounting Options:

- Standard mounting
Adhesive: Construction adhesive supplied separately
- Optional mounting
Standard Drilling: Clearance holes for #8 fastener wood screw.
Countersunk Drilling: #8 x 1 1/4" (31.75mm) oval head wood screw supplied separately as required.

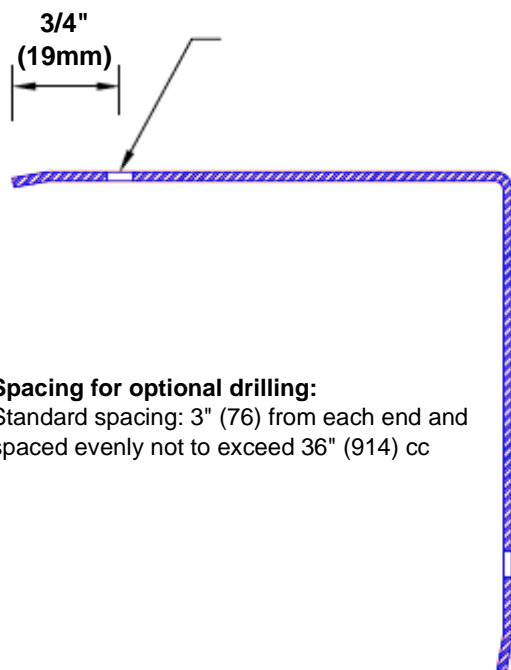

Spacing for optional drilling:

Standard spacing: 3" (76) from each end and spaced evenly not to exceed 36" (914) cc

