

# TheCornerGuardStore

## Pre-Anodized Aluminum Corner Guard

72" x 2 1/2" x 2 1/2" x 90°

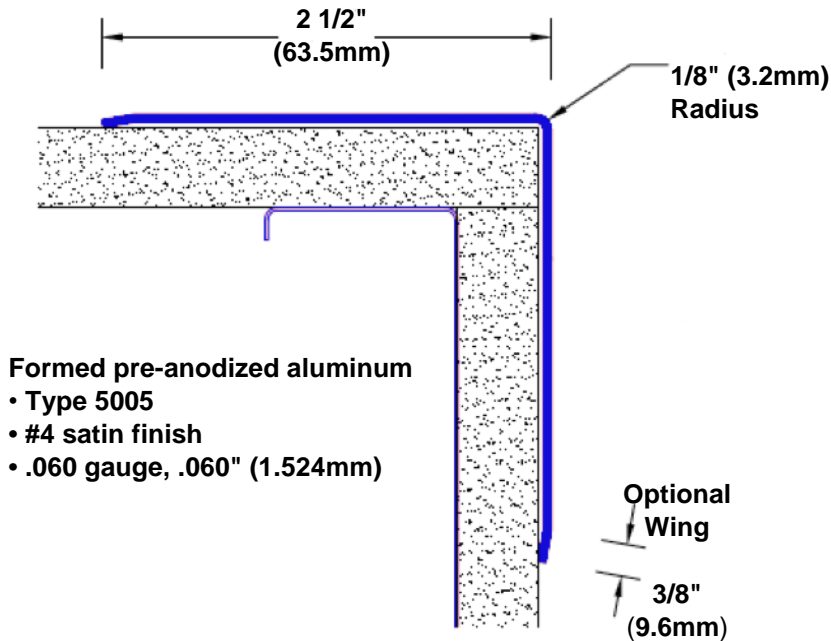

### Features:

- Custom lengths, angles and wing sizes
- Available with 3/4" (19) radius
- Type 5005 pre-anodized aluminum
- Stock lengths: 4' (1219mm) & 8' (2438mm)

### Mounting Options:

- Standard mounting  
Adhesive: Construction adhesive supplied separately
- Optional mounting  
Standard Drilling: Clearance holes for #8 fastener wood screw.  
Countersunk Drilling: #8 x 1 1/4" (31.75mm) oval head wood screw supplied separately as required.

