

REVISIONS			
REV.	DESCRIPTION	DATE	APPROVED

TheCornerGuardStore Hole Patterns for Corner Guards

Page 2 - 4ft and 5ft Corner Guard Hole Pattern

Page 3 - 6ft Corner Guard Hole Pattern

Page 4 - 7ft to 8ft Corner Guard Hole Pattern

Page 5 - Over 8ft Corner Guard Hole Pattern

Page 6 - 2ft Corner Guard Hole Pattern

Page 7 - 3ft Corner Guard Hole Pattern

UNLESS OTHERWISE SPECIFIED
DIMENSIONS ARE IN INCHES
TOLERANCES ARE:
FRACTIONS DECIMALS ANGLES
± .XX+ .XX -1
.XXX+.XXX

MATERIAL
Aluminum, Pre-Anodized Aluminum, Brass, Diamond Plate, Stainless Steel or any metal corner guard

FINISH
#4 or #8



THECORNERGUARDSTORE
WALL PROTECTION WAREHOUSE
TEL 800-516-4036 / TEL 763-432-3058 / FAX: 952-303-7337
SALES @ THECORNERGUARDSTORE.COM

CORNER GUARD STORE

B	DWG. NO.	REV.
	SCALE	CAD FILE:

8 7 6 5 4 3 2 1

REVISIONS			
REV.	DESCRIPTION	DATE	APPROVED

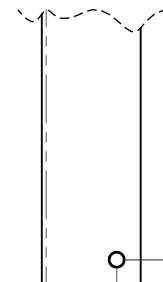
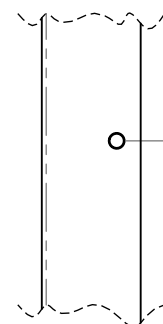
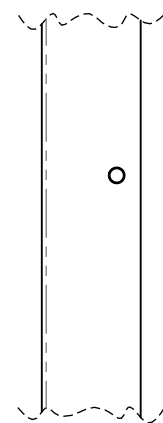
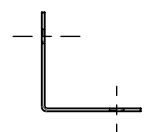

4' TO 5'
4 HOLES PER SIDE

EVENLY
SPACED

.500

.500



B

A

D

C

B

A

UNLESS OTHERWISE SPECIFIED DIMENSIONS ARE IN INCHES TOLERANCES ARE: FRACTIONS DECIMALS ANGLES ± .XX+ .XX -_1 .XXX+.XXX	
MATERIAL Aluminum, Pre-Anodized Aluminum, Brass, Diamond Plate, Stainless Steel or any metal corner guard	
FINISH #4 or #8	

THECORNERGUARDSTORE
WALL PROTECTION WAREHOUSE
TEL 800-516-4036 / TEL 763-432-3058 / FAX: 952-303-7337
SALES @ THECORNERGUARDSTORE.COM

CORNER GUARD STORE

B	DWG. NO. 4 TO 5 X2X2	REV.
SCALE	CAD FILE:	SHEET 1 OF 1

8 7 6 5 4 3 2 1

8 7 6 5 4 3 2 1

REVISIONS			
REV.	DESCRIPTION	DATE	APPROVED

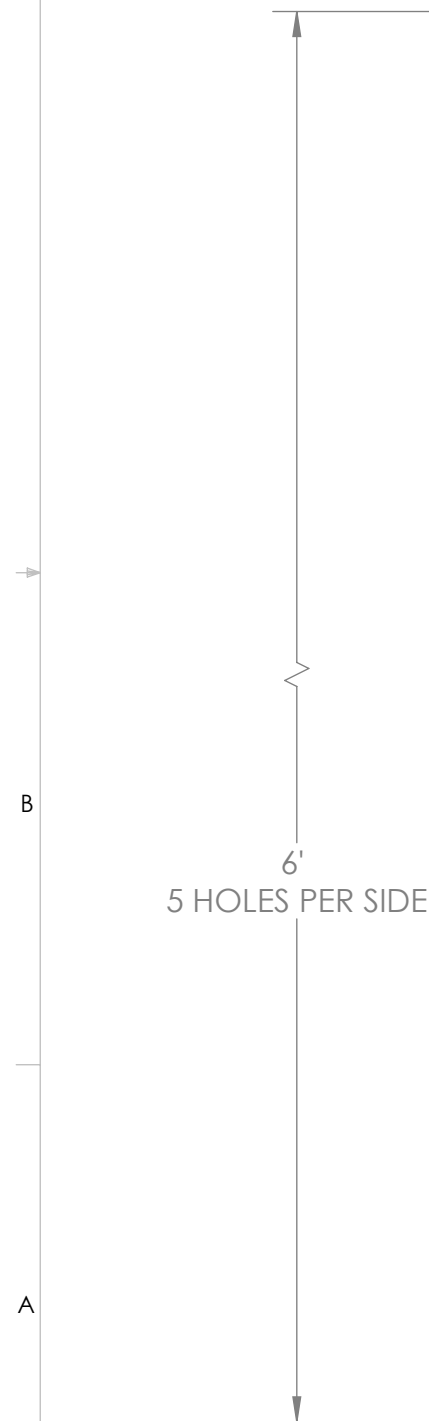
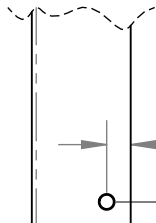
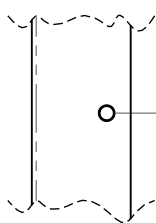
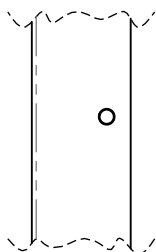
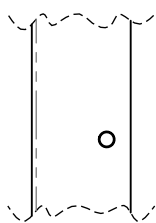
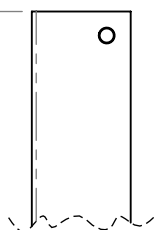

B
A

D
C
B
A

UNLESS OTHERWISE SPECIFIED
DIMENSIONS ARE IN INCHES
TOLERANCES ARE:
FRACTIONS DECIMALS ANGLES
± .XX+ .XX -_1
.XXX+.XXX

MATERIAL
Aluminum, Pre-Anodized Aluminum, Brass, Diamond Plate, Stainless Steel or any metal corner guard

FINISH
#4 or #8

THECORNERGUARDSTORE
WALL PROTECTION WAREHOUSE
TEL 800-516-4036 / TEL 763-432-3058 / FAX: 952-303-7337
SALES @ THECORNERGUARDSTORE.COM

CORNER GUARD STORE

B DWG. NO. **72X2X2** REV.
SCALE CAD FILE: SHEET 1 OF 1

8 7 6 5 4 3 2 1

REVISIONS

REV.	DESCRIPTION	DATE	APPROVED

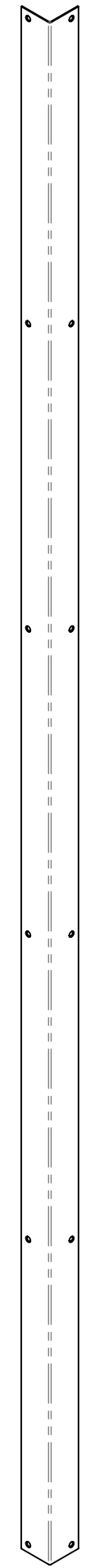
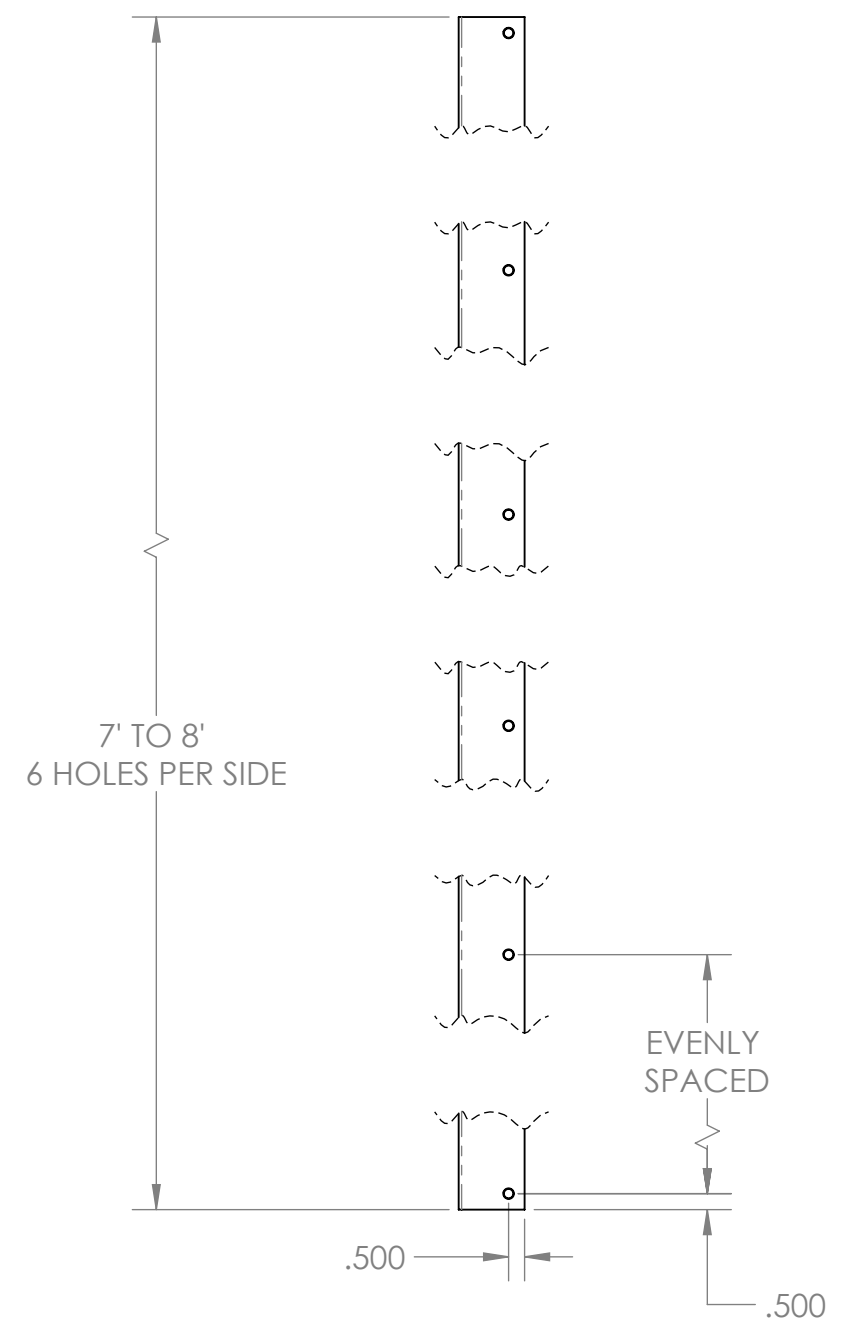
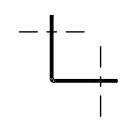

UNLESS OTHERWISE SPECIFIED
 DIMENSIONS ARE IN INCHES
 TOLERANCES ARE:
 FRACTIONS DECIMALS ANGLES
 ± .XX+ .XX +_1
 .XXX+.XXX

THECORNERGUARDSTORE
 WALL PROTECTION WAREHOUSE
 TEL 800-516-4036 / TEL 763-432-3058 / FAX: 952-303-7337
 SALES @ THECORNERGUARDSTORE.COM

MATERIAL
Aluminum, Pre-Anodized Aluminum, Brass, Diamond Plate, Stainless Steel or any metal corner guard

CORNER GUARD STORE

FINISH
#4 or #8

B	DWG. NO.	7 TO 8 X2X2	REV.
	SCALE	CAD FILE:	SHEET 1 OF 1

REVISIONS

REV.	DESCRIPTION	DATE	APPROVED

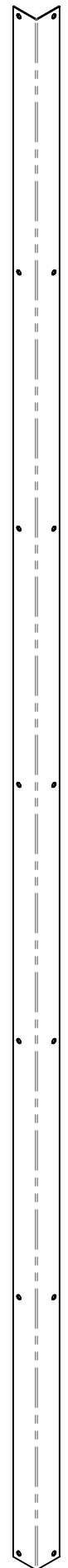
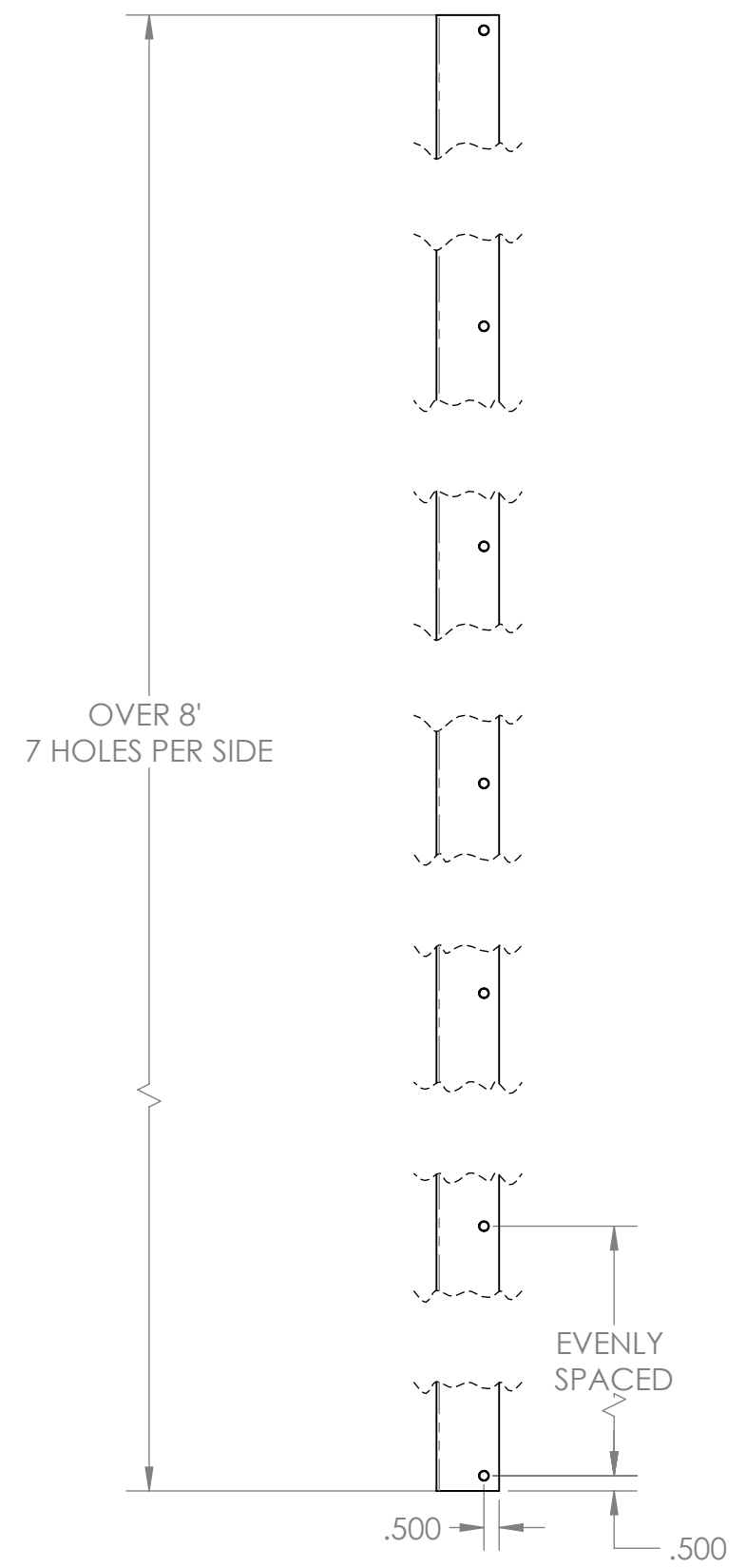
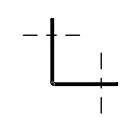

UNLESS OTHERWISE SPECIFIED
 DIMENSIONS ARE IN INCHES
 TOLERANCES ARE:
 FRACTIONS DECIMALS ANGLES
 ± .XX+ .XX -_1
 .XXX+ .XXX

MATERIAL
Aluminum, Pre-Anodized Aluminum, Brass, Diamond Plate, Stainless Steel or any metal corner guard

FINISH
#4 or #8

THECORNERGUARDSTORE
 WALL PROTECTION WAREHOUSE
 TEL 800-516-4036 / TEL 763-432-3058 / FAX: 952-303-7337
 SALES @ THECORNERGUARDSTORE.COM

CORNER GUARD STORE

SCALE	DWG. NO.	OVER 8FT X2X2	REV.
	CAD FILE:	SHEET 1 OF 1	

8 7 6 5 4 3 2 1

REVISIONS			
REV.	DESCRIPTION	DATE	APPROVED

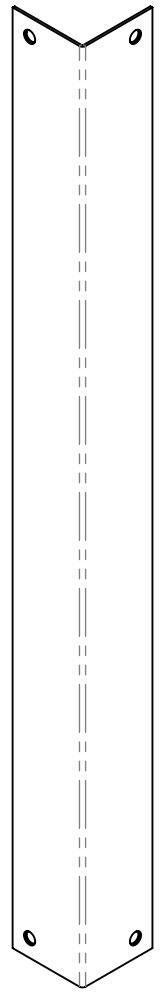
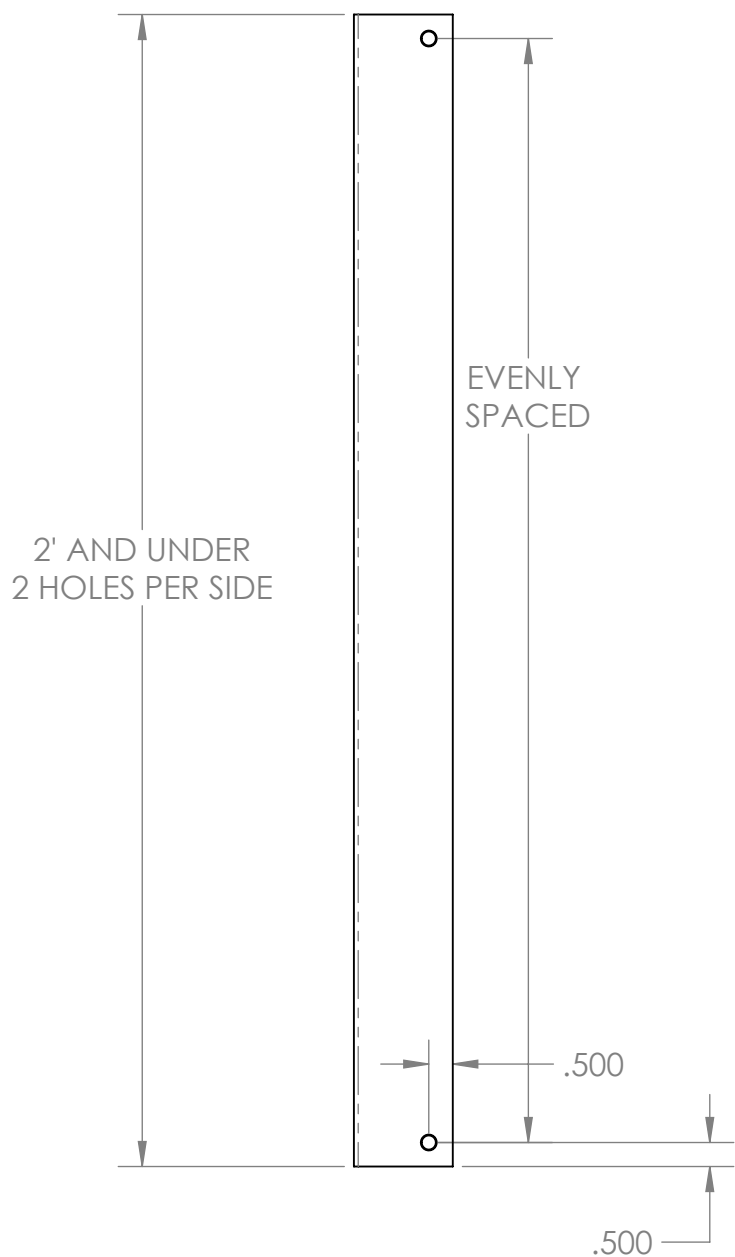
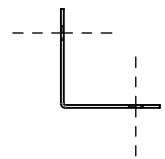

D
C
B
A

B
A

8 7 6 5 4 3 2 1

UNLESS OTHERWISE SPECIFIED
DIMENSIONS ARE IN INCHES
TOLERANCES ARE:
FRACTIONS DECIMALS ANGLES
± .XX+ .XX -_1
.XXX+.XXX

MATERIAL
Aluminum, Pre-Anodized Aluminum, Brass, Diamond Plate, Stainless Steel or any metal corner guard

FINISH
#4 or #8

THECORNERGUARDSTORE
WALL PROTECTION WAREHOUSE
TEL 800-516-4036 / TEL 763-432-3058 / FAX: 952-303-7337
SALES @ THECORNERGUARDSTORE.COM

CORNER GUARD STORE

B DWG. NO. **24X2X2** REV.
SCALE CAD FILE: SHEET 1 OF 1

REVISIONS			
REV.	DESCRIPTION	DATE	APPROVED

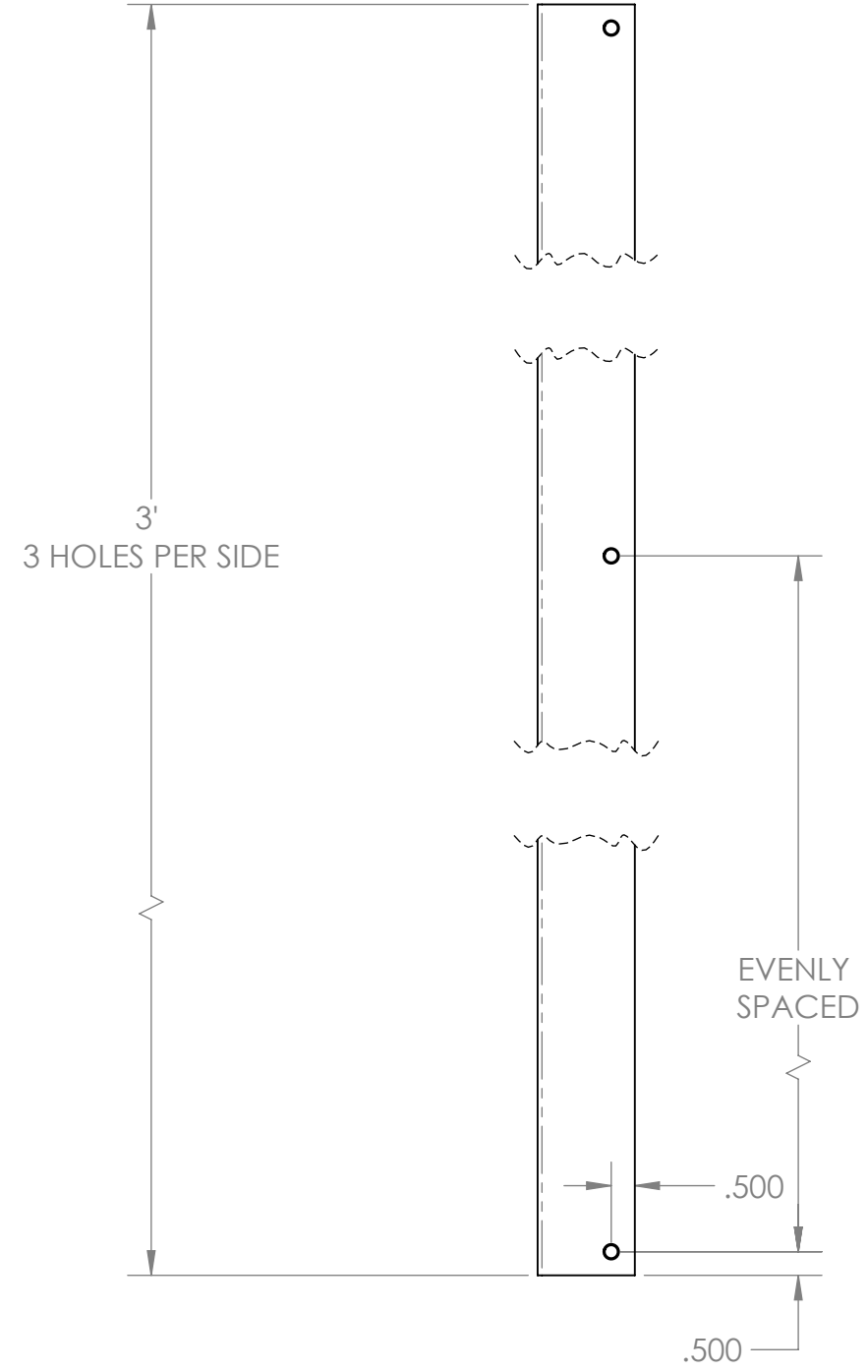
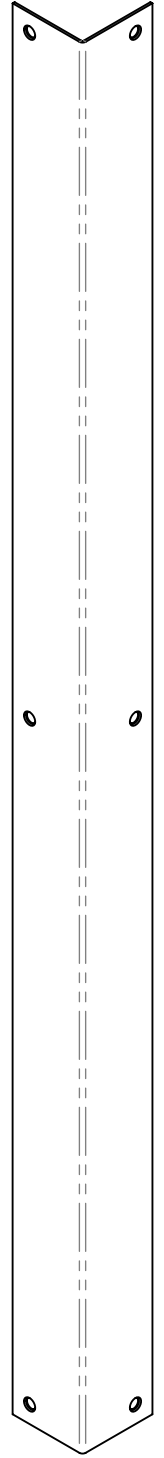
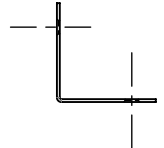

UNLESS OTHERWISE SPECIFIED
DIMENSIONS ARE IN INCHES
TOLERANCES ARE:
FRACTIONS DECIMALS ANGLES
± .XX+ .XX -_1
.XXX+.XXX

MATERIAL
Aluminum, Pre-Anodized Aluminum, Brass, Diamond Plate, Stainless Steel or any metal corner guard

FINISH
#4 or #8

THECORNERGUARDSTORE
WALL PROTECTION WAREHOUSE
TEL 800-516-4036 / TEL 763-432-3058 / FAX: 952-303-7337
SALES @ THECORNERGUARDSTORE.COM

CORNER GUARD STORE

B	DWG. NO.	36X2X2	REV.	
	SCALE	CAD FILE:	SHEET 1 OF 1	

