

TheCornerGuardStore

Diamond Plate Aluminum Corner Guard

72" x 4" x 4" x 90°

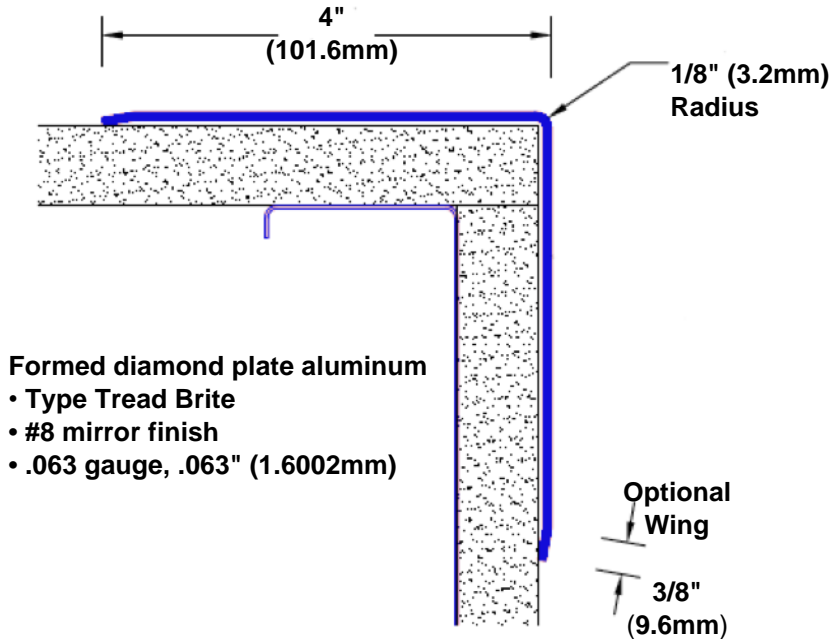

Formed diamond plate aluminum

- Type Tread Brite
- #8 mirror finish
- .063 gauge, .063" (1.6002mm)

Features:

- Custom lengths, angles and wing sizes
- Available with 3/4" (19) radius
- Type Tread Brite diamond plate aluminum
- Stock lengths: 4' (1219mm) & 8' (2438mm)

Mounting Options:

- Standard mounting
Adhesive: Construction adhesive supplied separately
- Optional mounting
Standard
Drilling: Clearance holes for #8 fastener wood screw.
Countersunk
Drilling: #8 x 1 1/4" (31.75mm) oval head wood screw supplied separately as required.

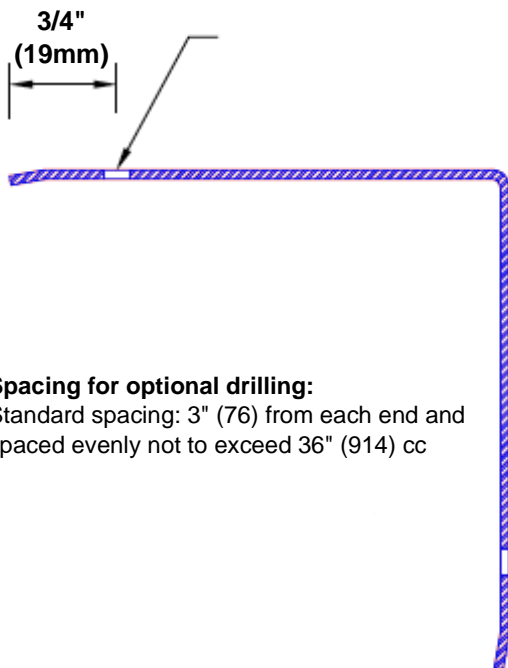

Spacing for optional drilling:

Standard spacing: 3" (76) from each end and spaced evenly not to exceed 36" (914) cc

