

TheCornerGuardStore™

Stainless Steel End Wall Cap 96" x 2" x 4.875" x 2" x 90°

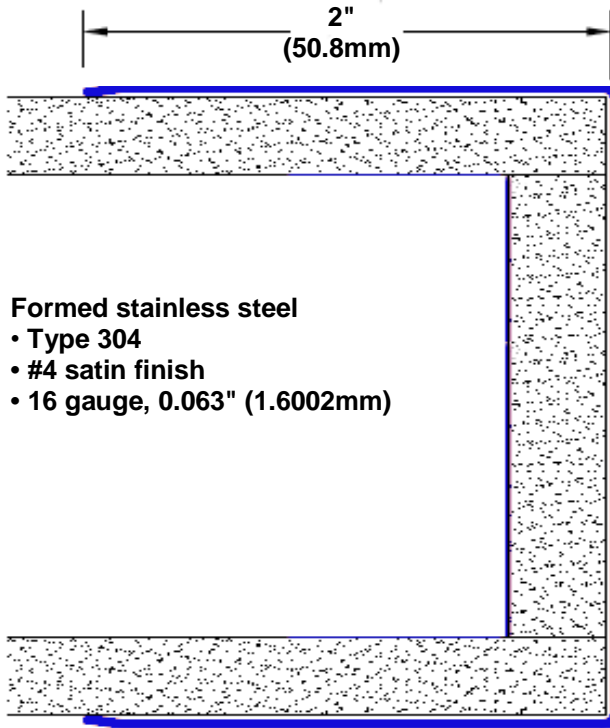

Features:

- Custom lengths, angles and wing sizes
- Type 304 stainless steel
- Stock lengths: 4' (1219mm) & 8' (2438mm)

Mounting Options:

- Standard mounting
Adhesive: Construction adhesive supplied separately
- Optional mounting
Standard Drilling: Clearance holes for #8 fastener wood screw.
Countersunk Drilling: #8 x 1/4" (31.75mm) ovalhead wood screw supplied separately as required.

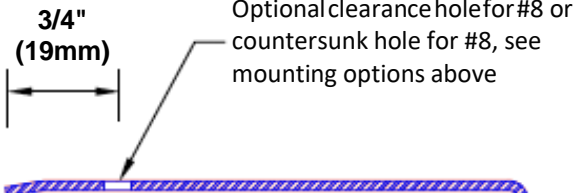
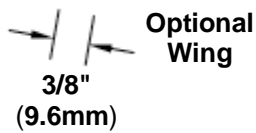

Spacing for optional drilling:
Standard spacing: 3" (76) from each end and spaced evenly not to exceed 36" (914) cc

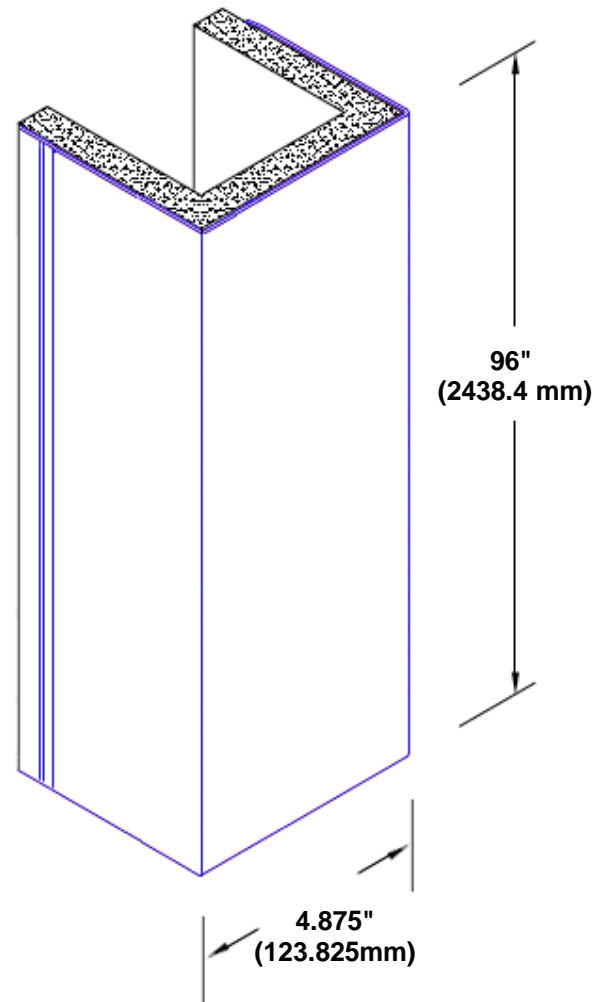

TheCornerGuardStore.Com reserves the right to discontinue a design or modify an existing design without prior notice