

TheCornerGuardStore™

Polycarbonate (Lexan) Corner Guard

92" x 2" x 2" x 90°

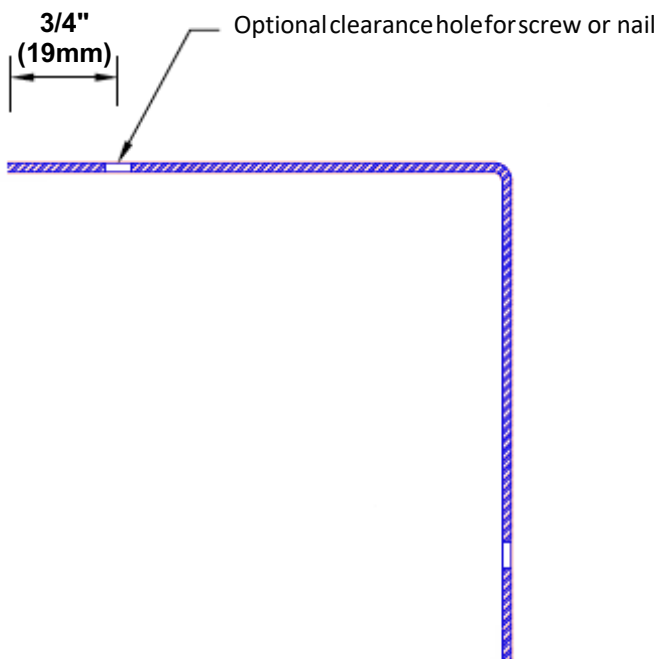
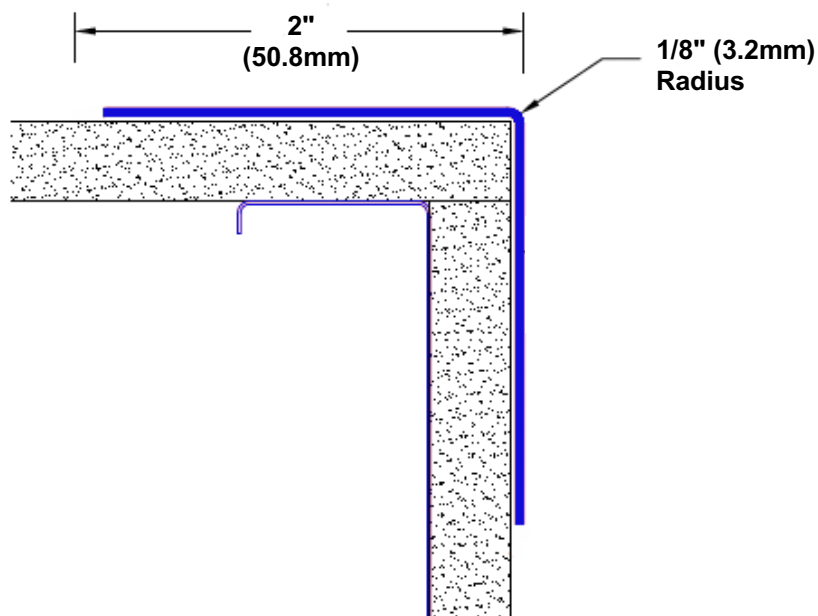

Features:

- Custom lengths, angles and wing sizes
- Available with 1/8" radius
- Material: POLYCARBONATE (LEXAN)
- Stock lengths: 4' (1219mm) & 8' (2438mm)

Mounting Options:

- Standard mounting
Adhesive:
Construction adhesive supplied separately
- Optional mounting
Standard Drilling:
Clearance holes for screw or nail
Self-Stick Tape

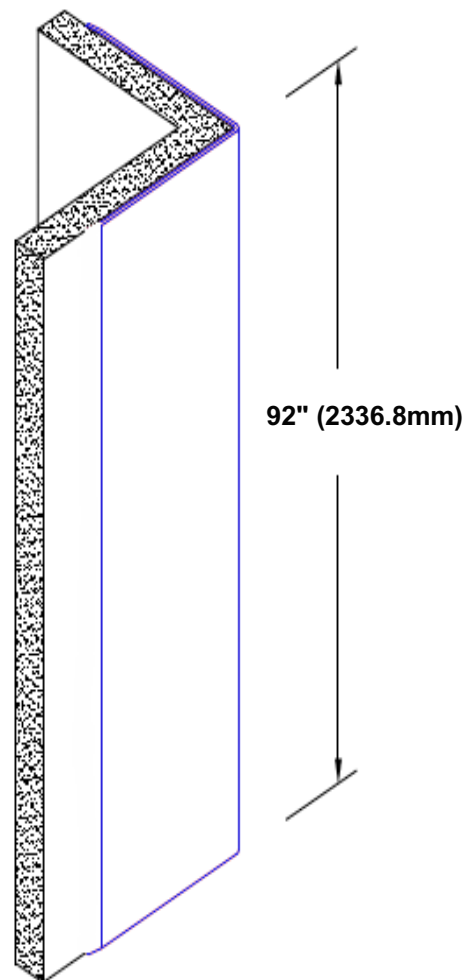

TheCornerGuardStore.Com reserves the right to discontinue a design or modify an existing design without prior notice