

# TheCornerGuardStore™

## Polycarbonate (Lexan) Corner Guard 92" x 2 1/2" x 2 1/2" x 90°

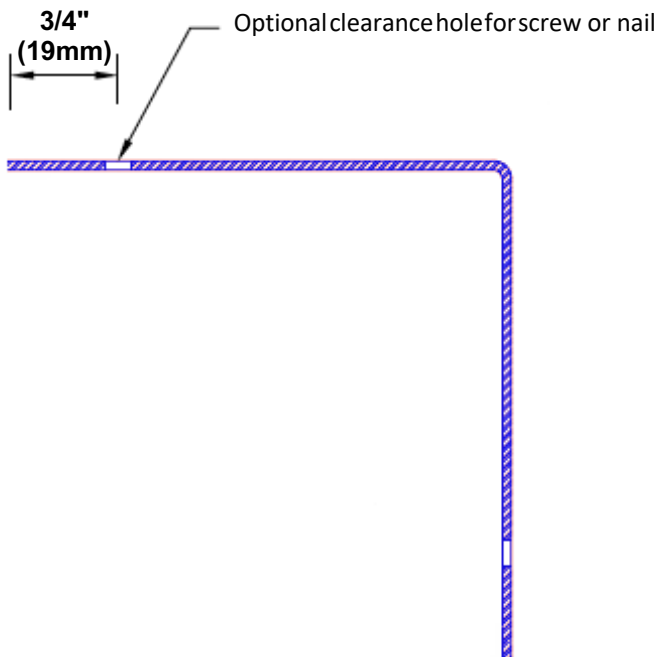
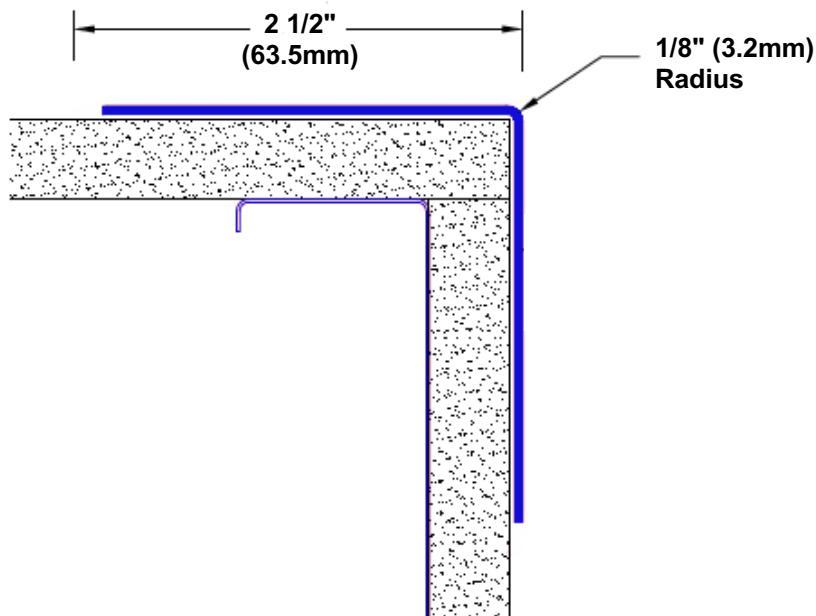

### Features:

- Custom lengths, angles and wing sizes
- Available with 1/8" radius
- Material: POLYCARBONATE (LEXAN)
- Stock lengths: 4' (1219mm) & 8' (2438mm)

### Mounting Options:

- Standard mounting  
Adhesive:  
Construction adhesive supplied separately
- Optional mounting  
Standard Drilling:  
Clearance holes for screw or nail  
Self-Stick Tape

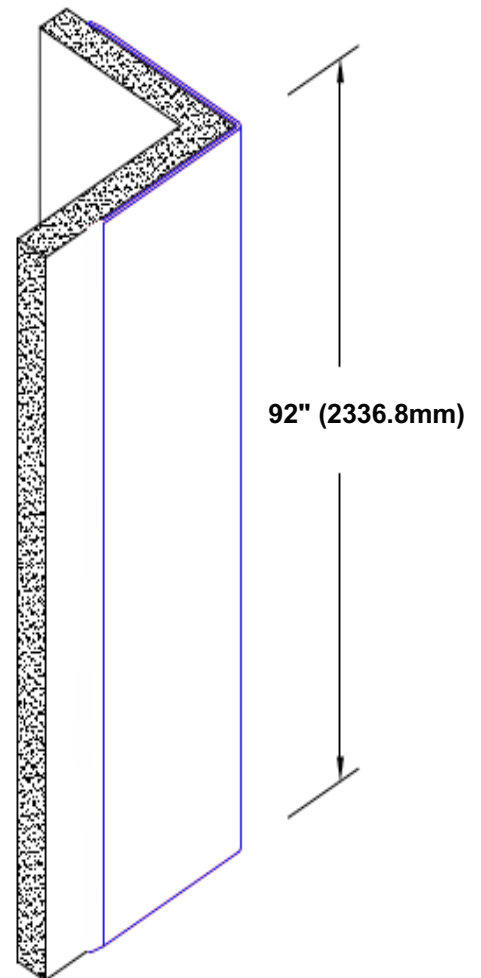

TheCornerGuardStore.Com reserves the right to discontinue a design or modify an existing design without prior notice