

CGFT-32 Corner Guard 1 Hour Fire Rated

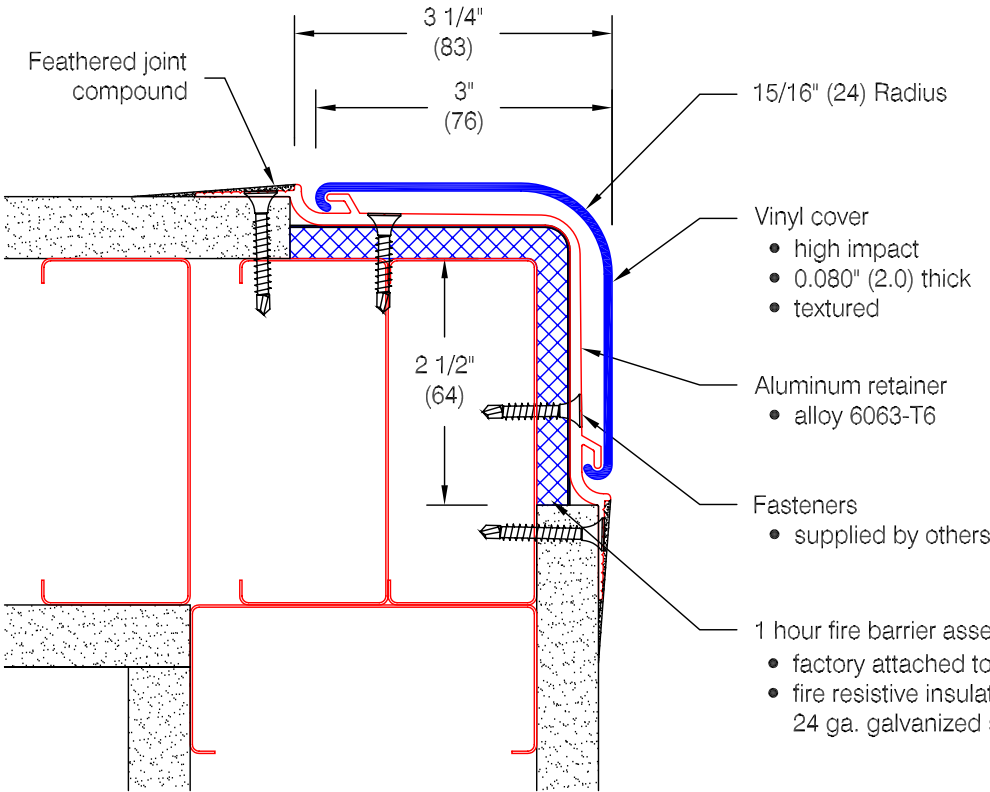

Features:

- Class A fire rating
- "Drop-in" installation follows completion of drywall mounting
- Stock lengths: 8'-0" (2438), 9'-0" (2743), 10'-0" (3048), and 12'-0" (3658)
- Custom cut lengths available
- Available with aluminum cove base insert for use with vinyl cove base standard in 4" (102) and 6" (152) heights

Finishes:

- Vinyl cover (textured)
 - Manufacturer's standard colors
 - Custom colors available
- Aluminum retainer
 - Mill finish aluminum

- 1 hour fire barrier assembly
 - factory attached to retainer
 - fire resistive insulation with 24 ga. galvanized steel backing

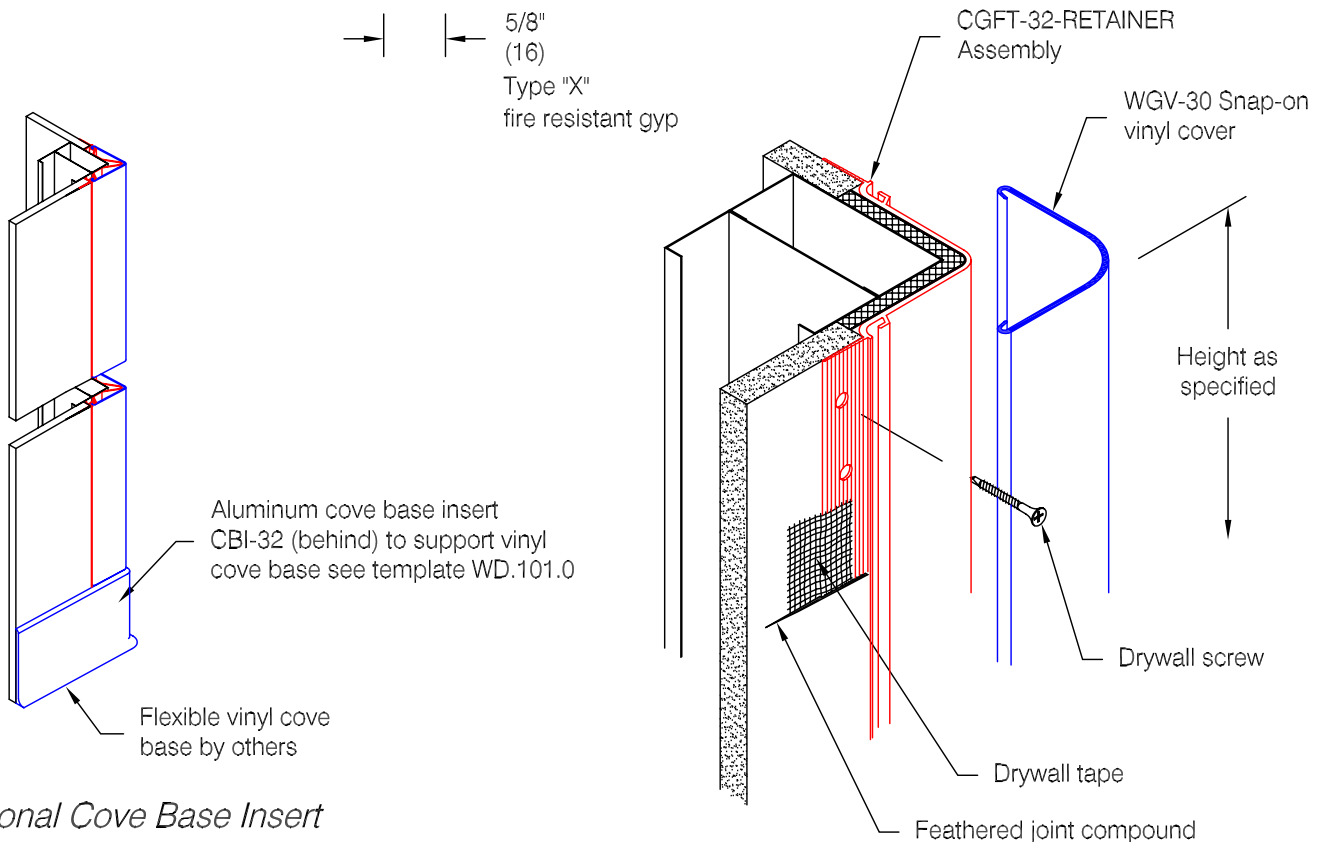

Optional Cove Base Insert

Pawling Corporation reserves the right to discontinue a design or modify an existing design without prior notice

Customer :	Project :	WD.86.2b
Architect :	Sales Rep :	