

# TheCornerGuardStore

## Stainless Steel Corner Guard

24" x 4 1/2" x 4 1/2" x 135°

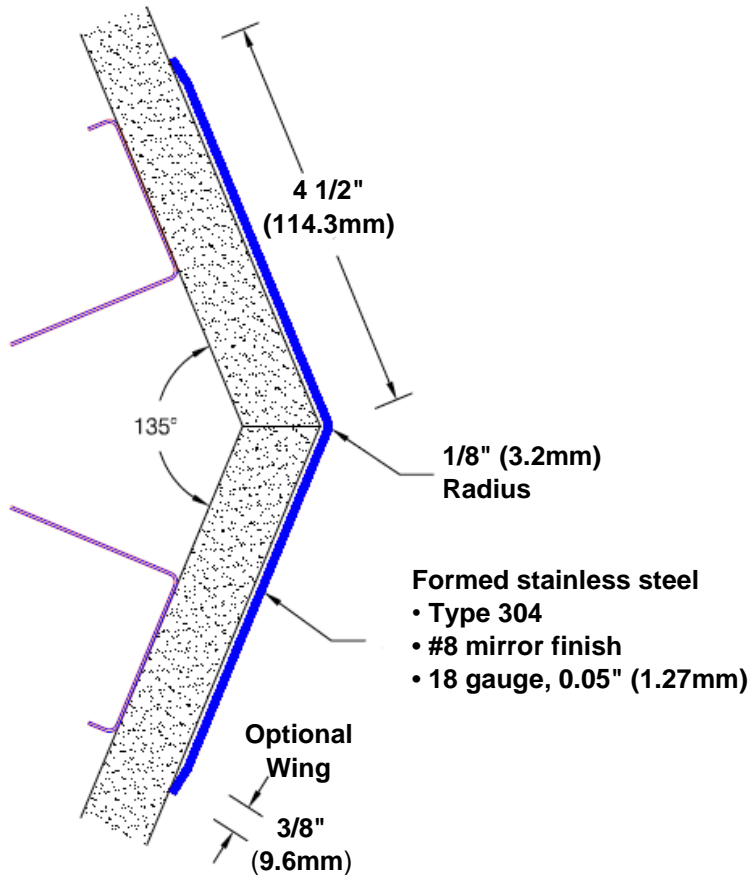

**Spacing for optional drilling:**  
Standard spacing: 3" (76) from each end and spaced evenly not to exceed 36" (914) cc



### Features:

- Custom lengths, angles and wing sizes
- Available with 3/4" (19) radius
- Type 304 stainless steel
- Stock lengths: 4' (1219mm) & 8' (2438mm)

### Mounting Options:

- Standard mounting  
Adhesive:  
Construction adhesive supplied separately
- Optional mounting  
Standard Drilling:  
Clearance holes for #8 fastener wood screw.  
Countersunk Drilling:  
#8 x 1 1/4" (31.75mm) oval head wood screw supplied separately as required.

