

TheCornerGuardStore

Stainless Steel Corner Guard

48" x 1" x 1" x 135°

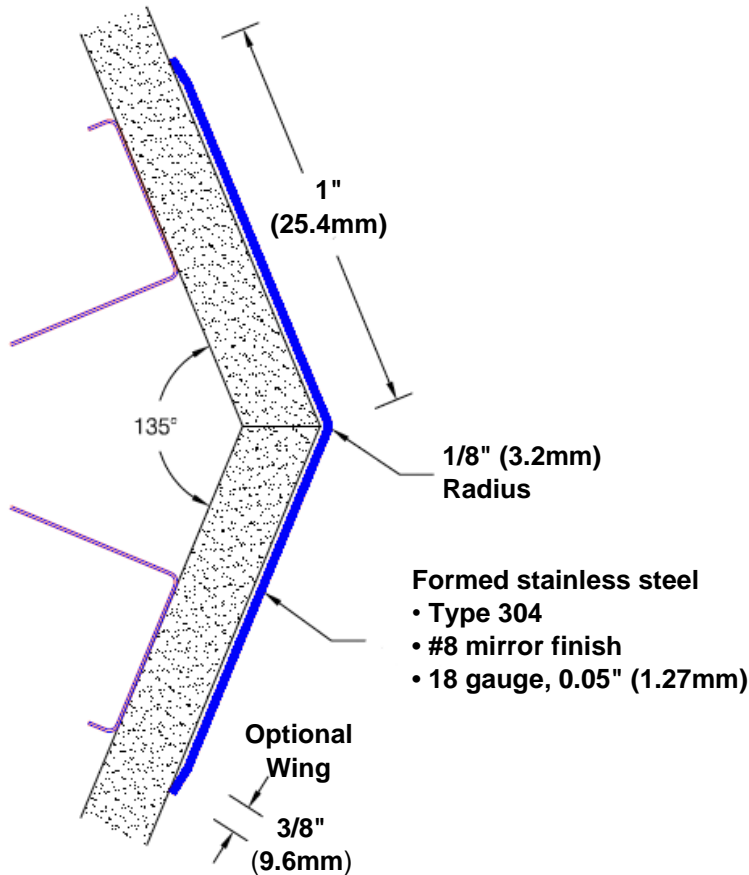

Spacing for optional drilling:
Standard spacing: 3" (76) from each end and spaced evenly not to exceed 36" (914) cc



Features:

- Custom lengths, angles and wing sizes
- Available with 3/4" (19) radius
- Type 304 stainless steel
- Stock lengths: 4' (1219mm) & 8' (2438mm)

Mounting Options:

- Standard mounting
Adhesive:
Construction adhesive supplied separately
- Optional mounting
Standard Drilling:
Clearance holes for #8 fastener wood screw.
Countersunk Drilling:
#8 x 1 1/4" (31.75mm) oval head wood screw supplied separately as required.

