

TheCornerGuardStore™

Surface Mount Vinyl Corner Guard with Retainer 92" x 2" x 2" x 90°

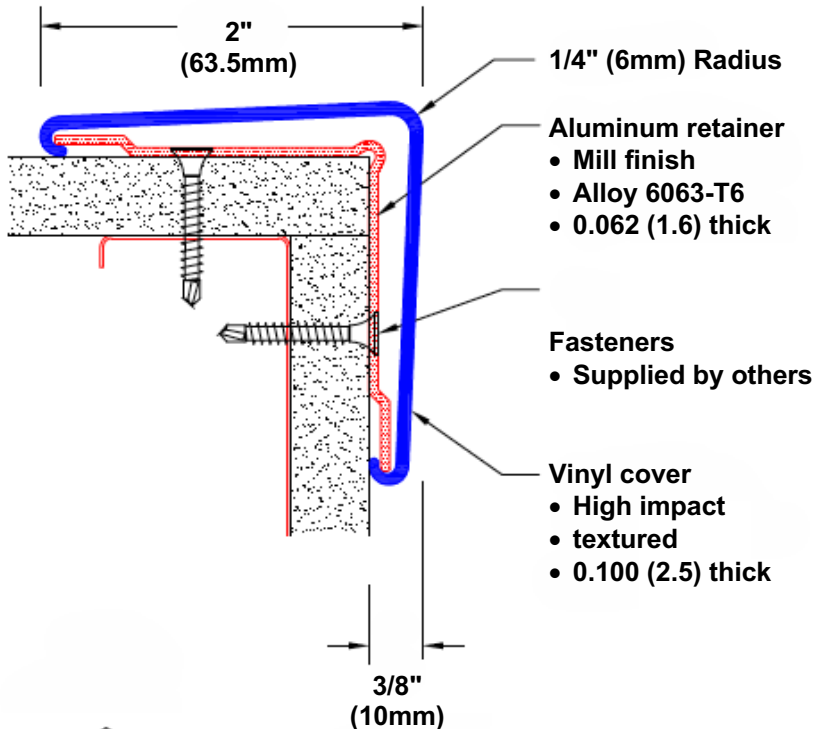

Features:

- Class A fire rating
- Surface Mount installation follows completion of drywall mounting
- Standard with textured top and bottom closure caps
- Stock lengths: 4' (1219mm) & 8' (2438mm)
- Custom lengths available

Finishes:

- Vinyl cover (textured)

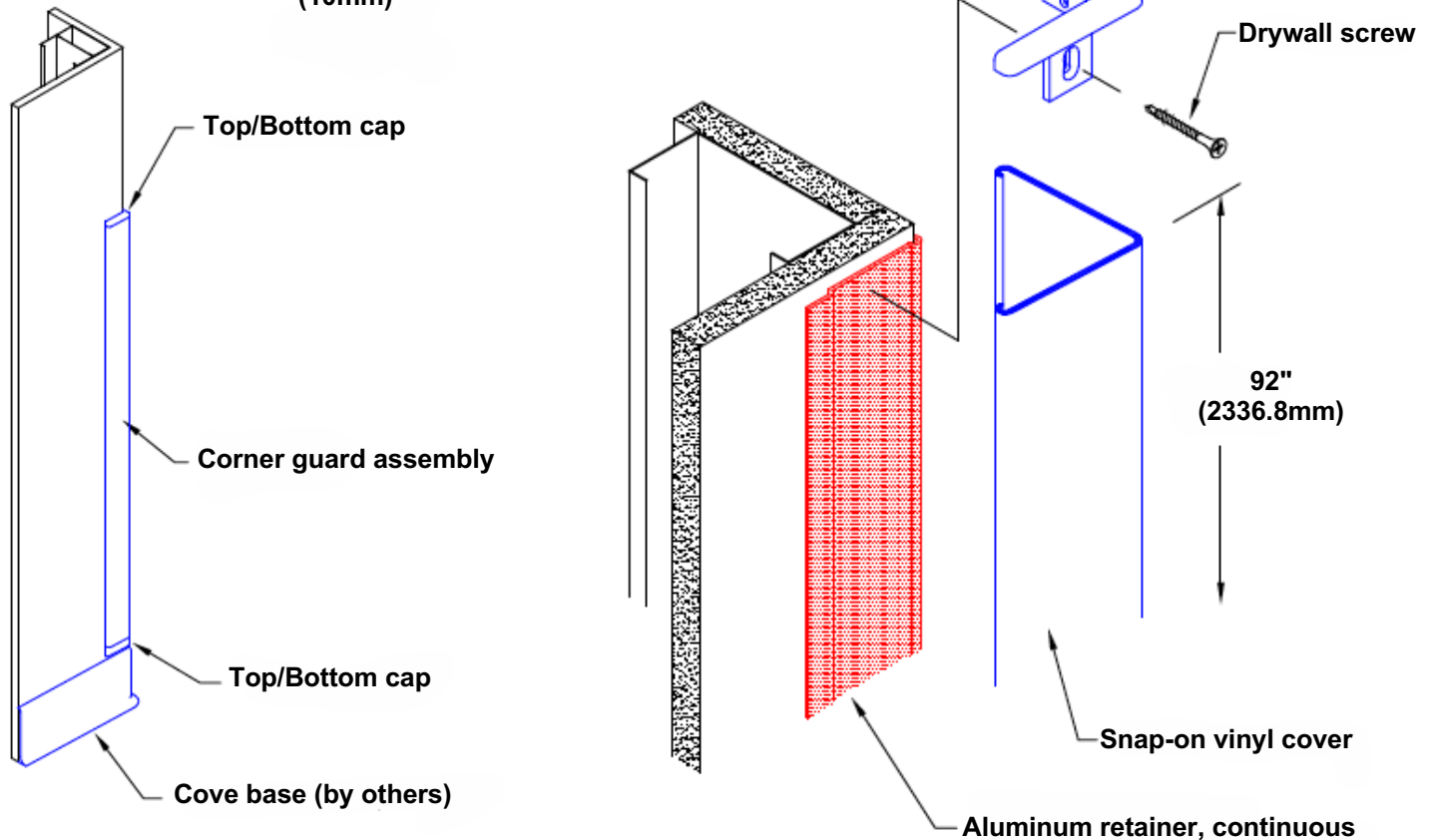

- **Partial height installation with top and bottom caps shown. Full height installations may not require top or bottom cap.**

TheCornerGuardStore.Com reserves the right to discontinue a design or modify an existing design without prior notice